

PQube® 3 Power Analyzers Installation Manual

PQube 3, 3e, 3v, 3r, 3LV
Revision 5



WARNING: Death, serious injury, or fire hazard could result from improper connection or operation of this instrument. Carefully read and understand manual before connecting this instrument.

AVERTISSEMENT: Si l'instrument est mal connecté, la mort, des blessures graves, ou un danger d'incendie peuvent s'en suivre. Lisez attentivement le manuel avant de connecter l'instrument.

WARNUNG: Der falsche Anschluß dieses Gerätes kann Tod, schwere Verletzungen oder Feuer verursachen. Bevor Sie dieses Instrument anschließen, müssen Sie die Anleitung lesen und verstanden haben.

ADVERTENCIA: Una conexión incorrecta de este instrumento puede producir la muerte, lesiones graves y riesgo de incendio. Lea y entienda el manual antes de conectar.







If this equipment is used in a manner not specified by the manufacturer, the protection provided by the equipment may be impaired. Installation, service, and maintenance of your PQube 3 must only be done by qualified personnel for electrical installations.

The information contained in this document is subject to change without notice.

POWERSIDE MAKES NO WARRANTY OF ANY KIND WITH REGARD TO THIS MATERIAL, INCLUDING, BUT NOT LIMITED TO, THE IMPLIED WARRANTIES OF MERCHANTABILITY AND FITNESS FOR A PARTICULAR USE.

POWERSIDE shall not be liable for errors contained herein or for incidental or consequential damages in connection with the furnishing, performance, or use of this material. If you do not accept this limitation on liability, please return the product to POWERSIDE prior to use.

Produced in the United States of America.

Symbol	Meaning
	Caution. Consult this manual in all cases where this symbol is marked, to find out the nature of the potential hazards and any actions which have to be taken to avoid them.
	Caution. Risk of electric shock
	Alternating current
	Alternating current (AC) or direct current (DC)
	Double or Reinforced insulation
	Functional earth terminal <u>not</u> relied on for safety

© 2008–2022 Powerside All rights reserved. No parts of this document may be copied, reproduced, or translated to another language without the prior written consent of Powerside. "PQube 3" is a registered trademark of Power Standards Lab. "Windows" "Excel," and "PowerPoint" are registered trademarks of Microsoft Corporation. All product names, trademarks and registered trademarks are property of their respective owners.

1	Introduction	5
1.1	What is a PQube® 3?.....	5
	Which power configurations are supported?	6
	Powering the PQube 3?	7
	Easy operation and communication with PQube 3?	7
1.2	PQube 3 Unique Features?	7
1.3	Overview of PQube 3 models and modules.....	8
1.3.1	PQube 3	8
1.3.2	PQube 3e	8
1.3.3	PQube 3v	9
1.3.4	PQube 3r	9
1.3.5	PQube 3LV	10
1.3.6	Modules and Accessories	11
1.4	Overview of PQube 3 Ports, Connections and Controls.....	12
1.5	Choosing Modules	14
1.5.1	Power PQube 3 from 100 to 240 Vac (PM1/PM2)	14
1.5.2	Backup PQube 3 during a power outage (UPS1/UPS2/UPS3)	14
1.5.3	Measure currents from secondary of current transformers (CTI-1A/CTI-5A)	15
1.5.4	Three Phase AC/Dual DC Voltage Attenuator (VAT2-600)	15
1.5.5	Relay Extension Module for load shedding (RM8)	16
1.5.6	Measure Environmental Conditions (ENV2)	16
1.5.7	Time Synchronize your PQube 3 clock to GPS time (GPS-R)	17
2	Installing the PQube 3	18
2.1	Unpacking the PQube 3	18
2.2	Installation.....	18
2.2.1	Disconnect mains prior to servicing	18
2.2.2	Mount your PQube 3 properly and securely	18
2.2.3	Include overcurrent protection and a disconnecting device	19
2.2.4	Protect the Operator from the Hazardous Terminals	19
2.2.5	Connect PQube 3 to the power supply	22
2.2.6	Connecting the wires	24
2.2.7	Connect Mains AC Voltage Wires	26
2.2.8	Protect antenna terminals from lightning	26

2.2.9	Installing a PM1 or PM2 Power Supply Module	27
2.2.10	Installing UPS Module	27
2.2.11	Installing Split Core Current Transformers (CTs)	28
2.2.12	Connecting the ENV2 Environmental Probes	32
2.2.13	Connecting the Output relay (RLY1)	32
2.2.14	PQube 3r/3vr: Connecting the Output relays (RLY2, RLY3, RLY4)	33
2.2.15	Installing GPS-R Sync Module (GPS Synchronization)	35
3	Wiring Diagrams	36
3.1	Wiring diagram for PQube 3v and PQube 3vr	36
3.2	Wiring Diagrams (PQube 3, PQube 3e, PQube 3r)	37
3.2.1	Single Phase L1-N	37
3.2.2	Single Phase L1-L2	37
3.2.3	Single phase 3-wire / Split Phase	38
3.2.4	Delta—3 CTs	38
3.2.5	Delta—2 CTs	39
3.2.6	Wye/Star	39
3.2.7	Measuring Neutral Current	40
3.2.8	Measuring Earth Current	40
3.2.9	Measuring Net Earth Current—Delta	41
3.2.10	Measuring Net Earth Current—Wye/Star	41
4	Configuring the PQube 3	42
4.1	Using the Configurator	42
4.2	Initial Device Setup	43
4.2.1	Set Current Transformer (CT) Ratio	44
4.2.2	Troubleshooting: Common Installation Errors	46
5	Maintenance	48
5.1.1	Turning Off PQube 3	48
5.1.2	Replacing PQube 3’s Clock Battery	48
5.1.3	Life Expectancy of the PQube 3 and the PM1/PM2 module	48
5.1.4	UPS1 Life Expectancy and Long-Term Storage Instructions	48
5.1.5	Cleaning Instructions	49
5.1.6	Reasons for reset	49
5.1.7	Calibration Information for Your PQube 3	49



1 Introduction

1.1 What is a PQube® 3?

PQube® 3 is an instrument for both monitoring and diagnosing issues with electric power systems and sensing environmental conditions, helping you to quickly solve problems that impact the quality and reliability of your product or process.

Think of it as a black box for your electric power, environment, and process: It is a unique combination of the best features of a power disturbance monitor, a power/energy meter, a process and environmental data logger, and a digital fault recorder. It's easy to install, intuitive, and no special training or software is required.

What does the PQube 3 record?

In a few words, your PQube 3 detects and records disturbances on the mains circuit: sags/dips, swells, interruptions, frequency variations, HF impulses, rapid voltage changes, waveform changes and more... It also records steady state power quality parameters like flicker, unbalance, THD harmonics and Interharmonics. PQube 3 is compliant with the most stringent Power Quality measurement standards: Class A IEC 61000-4-30 Ed3 (2015).

The PQube 3 is one of the few analyzers that measures 2 kHz-150 kHz conducted emissions.

Your PQube 3 automatically generates daily, weekly, and monthly trends/statistics reports.

When connected to compatible current transformers, your PQube 3 records current waveforms, RMS magnitude, current unbalance, and powers (watts, watt-hours, VARs, power factor, and other power-related parameters). The PQube 3 can monitor power and energy on several circuits.

The PQube 3 when equipped with POWERSIDE ultra-precise CTs, is fully compliant with IEC 61000-4-30, edition 3 Class A certified requirements and can be used as a revenue grade Class 0.2 energy meter.

Your PQube 3 includes 4 general-purpose channels for interfacing with voltage output types of sensors (RPM, torque, flow, vibration...). It has a digital input, which can be used as an external trigger source, and a relay contact output, used to notify alarms to an external indicator or PLC (the relay opens for at least 3 seconds for any detected event).

Your PQube 3, with up to 2 optional ENV2 environmental probes, can measure and trigger on temperature, humidity, barometric pressure and mechanical shocks, seismic disturbances, and vibration.

What software do you need?

You don't need special software to use your PQube 3. It records all data on internal memory or via a removable microSD card (32 GB max).

Your PQube 3 generates graphs for each disturbance detected, graphs for trends on daily, weekly, or monthly basis. Your PQube 3 also automatically generates summary reports.

No special software is required—just open the GIF picture files with standard image programs, Microsoft Word® and Microsoft PowerPoint®, or open the CSV files with any spreadsheet program such as Microsoft Excel®.

You configure your PQube 3 with our free PQube 3 Configurator program.

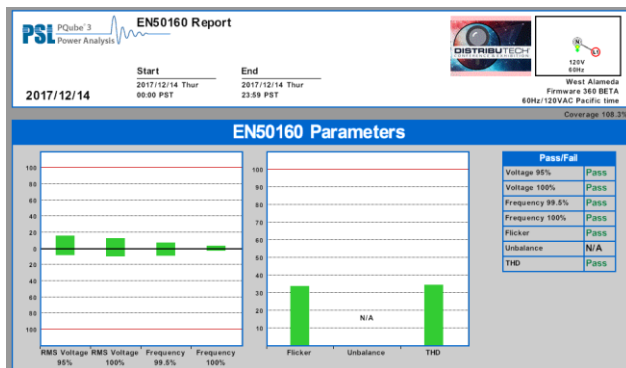
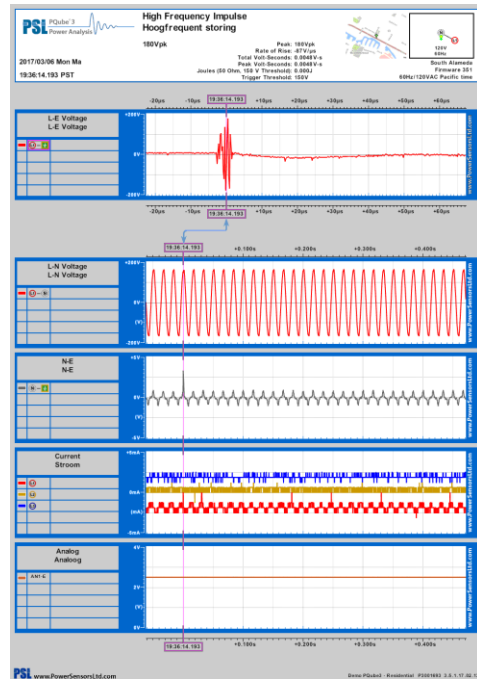

Which power configurations are supported?

Your PQube 3 can monitor circuits anywhere in the world from single phase, split phase to various types of 3-phase configurations: Wye/Star, Delta, Open Delta, Corner Grounded Delta.

In single-phase power configuration, nominal voltages can be auto detected from 69 Vac to 480 Vac line-to-neutral. In split single-phase power configuration, nominal voltages can be auto detected from 50 Vac to 480 Vac line-to-neutral, and 100 Vac to 960 Vac line-to-line. In 3-phase Wye/Star power configurations, nominal voltages can be auto detected from 50 Vac to 480 Vac line-to-neutral, and 100 Vac to 960 Vac line-to-line. In 3-phase Delta power configurations, nominal voltages can be detected from 100 Vac to 600 Vac line-to-line. It can auto-detect mains frequencies of 16.7 Hz, 50 Hz, 60 Hz, and 400 Hz. For medium and high-voltage applications, your PQube 3 supports PT ratios (up to 50000:1) and CT ratios configured to nominal secondary outputs with a low range of 0.333 Vrms or a high range of 3.33 Vrms (user selectable).

Beyond AC voltage, your PQube 3 can be used to monitor DC voltage at up to 60 Vdc, or up to 1200 Vdc with an optional ATT1 interface module. For both DC voltage and DC current, use the ATT2 interface module which can be useful, for example, in applications such as monitoring photovoltaic generation sites or battery banks of UPS.

Your PQube 3 with an additional VAT2 module can monitor both the input and output of a 3-phase UPS.

Powering the PQube 3?

It can be directly powered from 24 Vac or 24 to 48 Vdc source.

If a network hub with Power over Ethernet (PoE) is available, the PQube 3 can be powered from its Ethernet Port (48 Vdc).

If a wall power socket is available, you can power the PQube 3 with a plug-in PM1/PM2 module (range 100 Vac to 240 Vac, 50/60 Hz, or 120 Vdc to 370 Vdc).

Easy operation and communication with PQube 3?

No network is required to retrieve files from your PQube 3. Simply copy the data using a USB thumb drive or microSD card (32 GB max).

If a network connection is available, the PQube 3 can automatically send you emails whenever it detects an event. You can use the PQube 3 web server to send a new setup file and update its firmware. It includes a built-in web server, FTP server, and supports communication protocols including MODBUS, TCP/IP, SNMP, BACnet, and DNP3.

1.2 PQube 3 Unique Features?

There are many power quality meters, energy meters, and energy recorders available. What makes the PQube 3 unique?

No software. Open data—No specific software is required. All the data that the PQube 3 records is in standard easy to understand open formats. No need to buy or lease software from POWERSIDE or pay a fee to see or use your data.

Friendly data—Data is organized and presented to you in a format you can understand.

Works out of the box, or you can customize your configuration—Auto configuration, enables you to instantly measure and start recording data. You can change almost any setting using the PQube 3 Configurator program.

Works with or without a network—Plug the cable into your PQube 3's Ethernet Port and get emails when an event occurs, use your Internet browser to navigate through recorded events and trends. Real-time measurements are also available via communication protocols such as Modbus/TCP, SNMP (including traps), or DNP3.

Don't have a network? You can extract the data onto a USB thumb drive or microSD card (32 GB max) and look at all the files on any computer without proprietary software.

Store years of data in its internal flash memory—Your PQube 3 has a microSD card option (32 GB max), which can serve as a backup for the internal memory.

Ultra-compact size—The PQube 3 is compact and it's easy to integrate into your equipment, enclosure, or electrical panel.

1.3 Overview of PQube 3 models and modules

PQube 3 Power Analyzer family

1.3.1 PQube 3



PQube 3 is the most popular model in the family. It is easy to set up and comes from the factory with a default set up so you can “plug and go” for most installations. It auto-detects the mains frequency, wiring configuration and nominal voltage. You can connect directly to up to 750 volts (nominal) and the device computes 4-quadrant ANSI Class 0.2 revenue—grade energy on eight single-phase channels and is certified for Class A power quality according to IEC 61000-4-30 Ed3.

The PQube 3 holds years of data and thousands of events via 32 GB of internal flash memory.

1.3.2 PQube 3e



PQube 3e is the natural extension of PQube 3 with 6 additional current channels, giving you the ability to connect up to 14 energy metering channels.

The channels can be assigned in any combination of 4 three-phase loads or 14 single-phase loads. You can quantify energy costs by monitoring multiple loads with a single revenue-grade PQube 3e power analyzer.

1.3.3 PQube 3v



If you are focusing purely on voltage compliance, the **PQube 3v** is the best value: It connects the mains voltage directly at up to 750 Vac nominal.

The unit does a great job verifying electricity delivered at the Point of Common Coupling (PCC), as well as diagnosing equipment malfunctions. It monitors AC power (or DC voltage), but you can also monitor process parameters like speed or flow, by attaching sensors to the analog AC/DC channels.

You get the same ultra-precise results delivered immediately to your inbox.

Setup is identical to the PQube 3: You only need to configure voltage values and the unit uses the same easy-to-use Configurator tool.

1.3.4 PQube 3r



PQube 3r is the best choice for protecting sensitive processes that need accurate detection of power disturbances and flexible relay programming. The PQube 3r Power Analyzer has 4 built-in programmable relay outputs that can be individually assigned to a specific trigger condition associated to the type or severity of disturbance. The output relays can trigger on sag, swells, interruptions, wave shape changes, over/under frequency, high frequency impulses, and over/inrush current.

1.3.5 PQube 3LV



PQube 3LV is equipped with low voltage inputs ranging from 0 to 28 Vac nominal and up to 40 Vac maximum. These low voltage inputs are ideal for interfacing with medium voltage sensors in the distribution grid. This model has many equivalent features of the PQube 3 such as being a class 0.2 revenue grade meter and certified for Class A power quality according to IEC 61000-4-30 Ed3. Install the PQube 3LV in an outdoor enclosure for applications that require power to be analyzed in the distribution grid, data centers, or harsh outdoor environments.

1.3.6 Modules and Accessories

Each PQube 3 comes standard with the following features:

- Three AC mains voltage channels
- Eight current channels (for CTs with 0.333 Vac secondary), fourteen channels for PQube 3e
- Four analog input channels for additional signals (for example, the output of a power supply)
- One digital input channel (monitor the state of an interlock switch)
- One signal output relay (notify your PLC that an event has occurred)
- Power supply input rated for 24 Vac or 24 to 48 Vdc
- One 10/100 Ethernet Port (PoE compatible)
- One high-speed USB 2.0 port (for USB Drive or ENV2 environmental probe)
- Two standard USB 1.0 ports (for ENV2 environmental probes)
- Full-color touchscreen
- 32 GB internal memory
- One USB Drive included with each PQube 3 (contains manual, quick-start guide, setup file, Configurator program, and Report Writer program)

Several types of modules and accessories are available, including:

- AC/DC Interface: VAT2, ATT1, and ATT2
- Power Supply and Backup: PM1, PM2, UPS1, UPS2, and UPS3
- Time and Synchronization: GPS-R
- Relay Extensions: RM8
- Environment Sensors: ENV2
- Current Interface for 1A/5A CT Secondaries: CTI-1A and CTI-5A

Frequently asked questions on choosing modules for specific applications:

- Will the PQube 3 be powered from 100 to 240 Vac (50/60/400 Hz) and if so, is battery backup required in the event of a power outage? **See Power Supply and Backup Module Options in “Choosing Modules” section**
- Do I need current inputs to measure the 1 A or 5 A secondary of a CT at ANSI Class 0.2 or IEC 62053-22 Class 0.2S revenue energy accuracy? **See CTI Series CT Interface Modules in “Choosing Modules” section**
- Do I need GPS time stamps on my data? **See GPS-R Time and Sync Module in “Choosing Modules” section**
- Do I want to record the environmental conditions such as temperature, humidity, pressure, or acceleration? **See ENV2 Environmental Sensor in “Choosing Modules” section**



Below is an overview of the PQube 3 family and accessories. The left-hand connected modules include the GPS-R, RM8 relay, and CTI 1A/5A modules. The right-hand connected modules include the PM1/PM2 power supplies and UPS 1/2/3 power backup modules. Other accessories include the ATT1/ATT2/VAT2 attenuators, split core CTs, and ENV2 environmental probes.

1.4 Overview of PQube 3 Ports, Connections and Controls

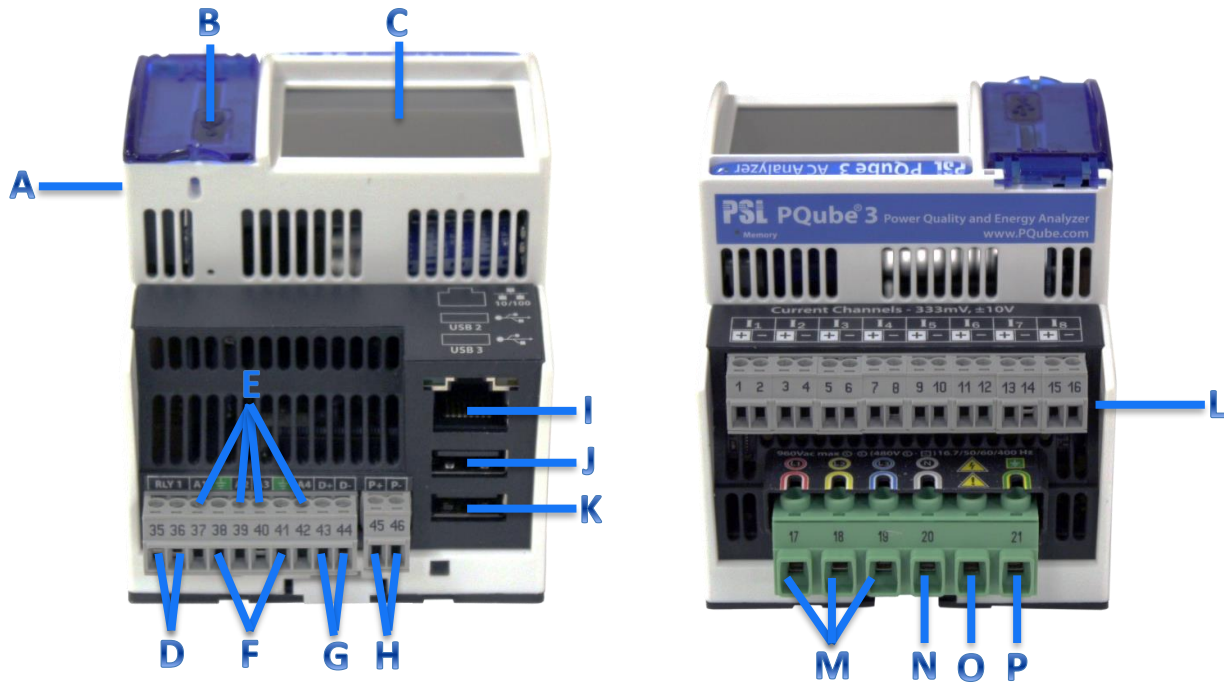



A	Coin-cell battery (keeps real time clock alive when instrument power is lost)
B	USB-1 High-Speed USB 2.0 Port for USB hard drives and adjacent microSD card slot (format using FAT32 file system)
C	Touchscreen display
D	Signal relay output. Normally closed during recording mode. Opens ½ cycle after the event or device shutdown.
E	Analog inputs. Maximum ±60 Vdc or 33 Vac to earth. Can be used as differential inputs.
F	Earth—functional. Use as a reference point for analog inputs (not needed if using analog channels in differential mode).
G	Digital input. Wetted with 2.4 V at 3 microamps. 1.5 V threshold. 60 V maximum.
H	Power supply input. 24 Vac or 24 Vdc to 48 Vdc (either polarity) nominal. 20 VA max

I	10/100 Ethernet RJ-45 Port. 48V PoE compatible.
J	USB-2 Standard USB 1.0 Port for use ONLY with ENV2 environmental probes.
K	USB-3 Standard USB 1.0 Port for use ONLY with ENV2 environmental probes.
L	Current transformer inputs—nominal 0.333 Vac RMS (LOW range) or ±10V _{pk} (HIGH range)
M	 L1, L2, L3 voltage inputs. See Section 2.2 for maximum voltage ratings.
N	 Neutral terminal—optional depending on your power configuration
O	Not connected, for isolation from ground.
P	 Earth—functional. Used as the reference point for voltage measurements. IMPORTANT: This terminal must be properly connected to ground for safety, accuracy, and reliability.

1.5 Choosing Modules

1.5.1 Power PQube 3 from 100 to 240 Vac (PM1/PM2)



If you have 24 to 48 Vdc or 24 Vac, you can use your PQube 3's internal power supply (just connect the voltage to the power supply screw terminal blocks).

If you need to power your PQube 3 from 100 to 240 Vac, you'll need the plug-in PM1 or PM2 Power Manager module.

The PM2 module also includes a 24 Vdc auxiliary output so you can power small accessories (up to 5 W) like LEDs or fans.

1.5.2 Backup PQube 3 during a power outage (UPS1/UPS2/UPS3)

UPS1



Connect the UPS1 Battery Backup module to your PQube 3 to provide up to 30 minutes of backup power during a power outage. It can be used with or without a PM1 or PM2 module. The operating temperature range is 0°C to 45 °C.

UPS2 and UPS3

Extended autonomy models are available: The UPS2 backup module provides extended power backup (up to one hour) with a POWERSIDE XB1 lead acid battery pack. The UPS3 is identical to UPS2 but also includes power source to back up 5 watts of accessories. Both units offer a wide temperature range of -20 °C to 65 °C for severe environments.



1.5.3 Measure currents from secondary of current transformers (CTI-1A/CTI-5A)



Your PQube 3 comes standard with 8 current channels which are compatible with CTs with 0.333 Vac secondary.

But if you need to measure CTs with 1A or 5A secondary wires for your application, use the CTI Current Transformer Input module.

There are two versions: one with 1A input and one with 5A input. Use the CTI module that matches the secondary rating of your external CTs.

There are four current inputs per module. Your PQube 3 can accommodate up to two CTI modules.

Use this module if your application requires ANSI C12.20 Class 0.2 or IEC 62052-22 Class 0.2S revenue grade accuracy.

1.5.4 Three Phase AC/Dual DC Voltage Attenuator (VAT2-600)



The perfect solution for monitoring two sets of three-phase AC voltages such as the primary and secondary side of transformers or the input and output of a three-phase UPS.

1.5.5 Relay Extension Module for load shedding (RM8)



You can now turn your PQube 3 into a powerful controller and command the shedding of loads to protect your main distribution circuit from tripping.

The RM8 extension relay module easily plugs in to your PQube3 (also PQube 3e) and its 8 relays are fully programmable.

This allows you to customize your load shedding scheme by assigning incremental thresholds, or by applying the scheme to protect up to 4 circuits. And the PQube 3 power Analyzer measures, reports in real-time, and records the power, VA, VARs, and Power Factor of all the circuits monitored.

1.5.6 Measure Environmental Conditions (ENV2)



The ENV2 environmental probe allows your PQube 3 to measure ambient temperature, humidity, and barometric pressure.

It also includes an accelerometer to measure shock and vibration, a thermocouple input for wide temperature ranges, and a solar irradiation input.

Connect up to 2 probes to your PQube 3 using a microUSB to USB cable.

You can use a USB cable with a length of up to 15 ft /5 m.

1.5.7 Time Synchronize your PQube 3 clock to GPS time (GPS-R)



Your PQube 3 can synchronize its time clock to GPS, which provides a 1 microsecond internal clock accuracy. This is useful for Class A measurements, or if you need time synchronization for diagnostic and troubleshooting purposes.

The GPS-R module interfaces with OEM TNC type GPS antennas to provide your PQube 3 with ultra-precise time (no drift) timestamping for power quality events.

The GPS-R receiver locks onto GPS satellites to provide your PQube 3 with ultra-precise GPS timing.

Connect the GPS-R module using an RG58C/U cable with 50-ohm impedance with maximum attenuation of 20 dB. The maximum cable length is 50 ft cable length.

2 Installing the PQube 3

2.1 Unpacking the PQube 3



Verify that your package contents are complete:

- 1 PQube 3
- 1 USB thumb drive (contains the manual, quick-start guide, setup file, Configurator program, and Report Writer program)
- 1 six-pole voltage connector (mains voltage)
- 8 two-pole connectors (current inputs)
- 1 two-pole connector (power supply)
- 1 ten-pole connector (for analog channels, digital input, relay output)

Note:

- *PQube 3e comes with an additional 6 two-pole connectors (additional current inputs)*
- *PQube 3v, PQube 3vr do not have current terminals nor connectors*
- *PQube 3r and PQube 3vr come with a set of 3 three-pole connectors (for the additional 3 relays)*

2.2 Installation

2.2.1 Disconnect mains prior to servicing

IMPORTANT: Your PQube 3 must be installed only by qualified personnel for electrical installations.

Always disconnect all mains connections, and verify disconnections, prior to servicing.

In the United States and Canada, the equipment installation shall meet ANSI/NFPA 70, NEC, with CSA C22.1, CEC, Part I or with both as appropriate. In other countries, follow all local installation requirements and regulations.

2.2.2 Mount your PQube 3 properly and securely

Your PQube 3, and its optional modules, are designed to be mounted on an industry standard 35 mm DIN rail as rack- or panel-mounted equipment.

Example installation:



GPS module on left
side of PQube 3

PQube 3 (main module)

PM1/PM2 Module
on right side of
PQube 3

UPS1 Module
on far-right
side

2.2.3 Include overcurrent protection and a disconnecting device

An external overcurrent protection device, such as a fuse or a circuit breaker, must be installed on each mains connection. The recommended fuse rating is 2 A, 600 Vac, 200 kA IR AC, Time Delay, and Class CC. The **device shall be UL Listed, branch circuit type overcurrent protector. You should consult a qualified electrician to determine the overcurrent protection installation.**

Your PQube 3 can share the overcurrent protection device with other loads.

An operator-activated disconnecting device, such as a switch or a circuit breaker, must be installed on the mains connections. The recommended disconnecting device rating is 600 Vac/dc, Max 30 A, SCCR: 200 kA This device must be clearly marked as the disconnecting device for your PQube 3 and must be marked to indicate the disconnection function. Do not install your PQube 3 in such a way that it becomes difficult to operate this disconnecting device. The disconnecting device must not disconnect the earth connection. The disconnecting device should be installed near your PQube 3, within easy reach of the operator.

2.2.4 Protect the Operator from the Hazardous Terminals

IMPORTANT: All high-voltage parts must be covered, including the AC power to your PQube 3. Install your PQube 3 so that all the screw terminal blocks are not accessible¹ to the operator. Your PQube 3 can also be installed without a cover if installed in a lockable UL 508 control panel.

¹ Accessible, as defined in UL 61010-1, means able to be touched with a standard test finger or test pin, when used as specified in UL61010-1 6.2.

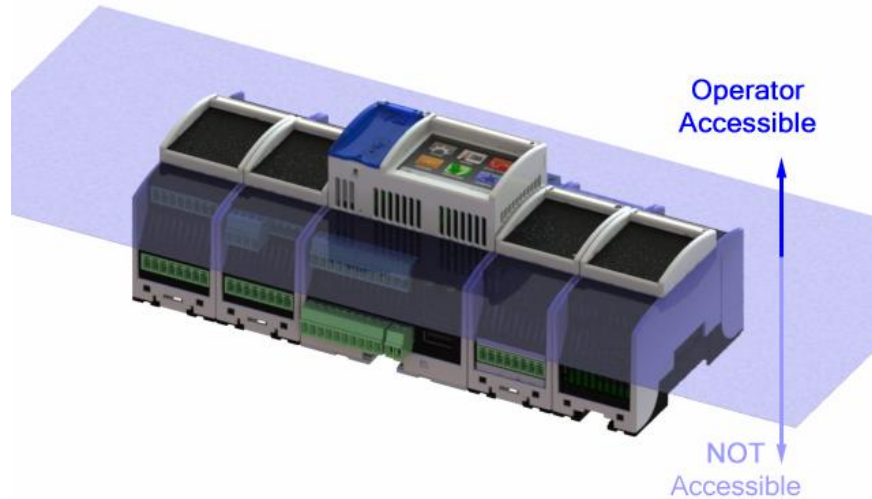

The operator must be protected from the hazardous screw terminal blocks by a barrier. The screw terminal blocks must be made “not accessible,” as defined in UL /IEC 61010-1 6.2, using an enclosure or barrier that meets the rigidity requirements of UL /IEC 61010-1 8.1 and that requires a tool to remove.

If you choose to install your PQube 3 in an enclosure, select a UL-listed enclosure that is appropriate for the purpose. If you plan to use an enclosure of this type, you should review its mechanical compatibility with any optional features of your PQube 3 that you plan to use: optional USB connections, optional temperature-humidity probes, etc.



The PQube 3 input circuits are isolated from earth potential. The reference diagram and table below show the respective circuit and isolation rating for each PQube 3 input.

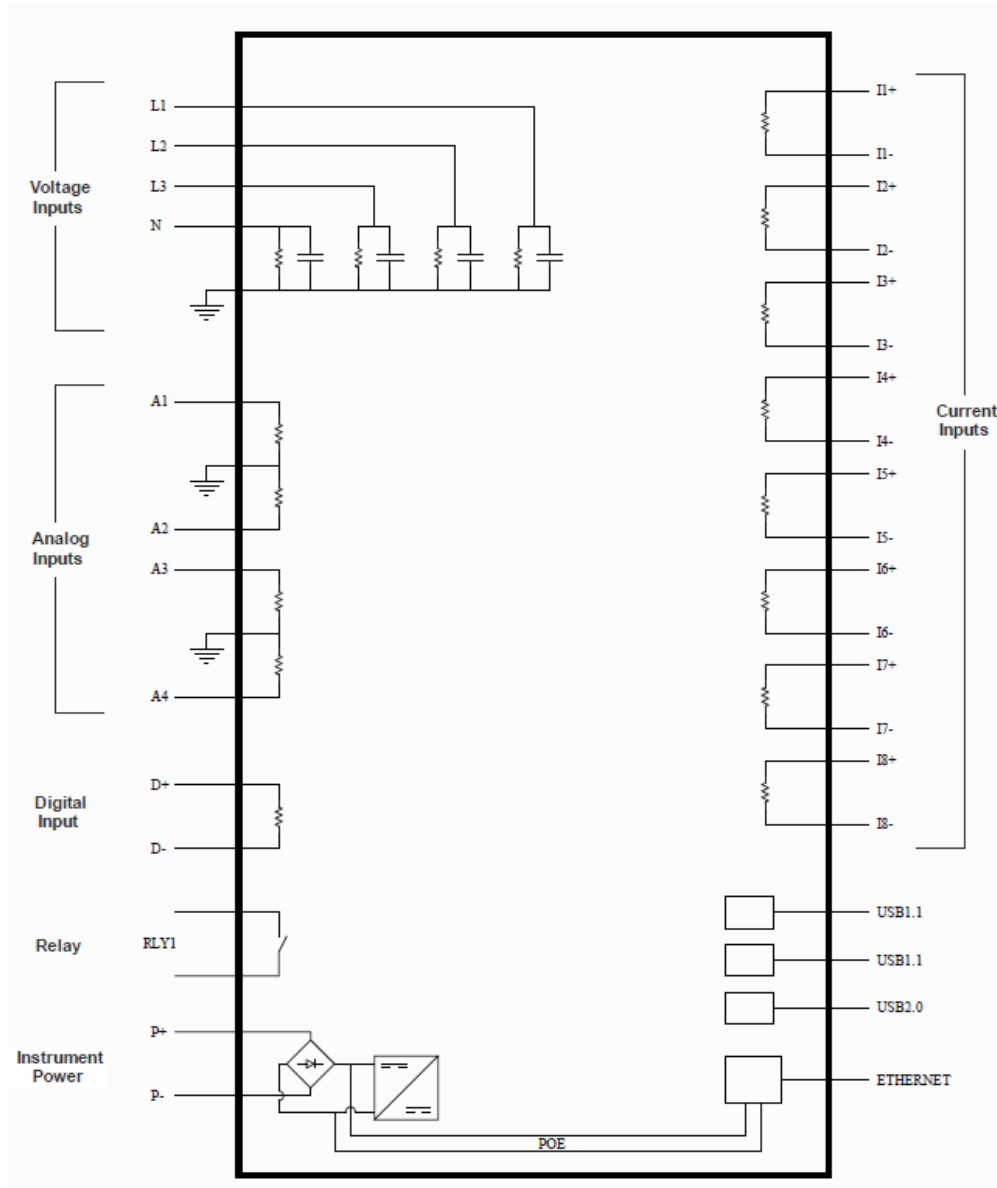

Isolation Table	
Voltage inputs	4.8 MΩ 7 pF to Earth
Current inputs	33.3 kΩ differential, 10 kΩ common-mode to Earth
Analog inputs	1 MΩ to Earth
Digital input	>500 kΩ differential, >100 kΩ common-mode to Earth
Relay	1500 V isolation to Earth
Instrument power	1500 V isolation to Earth
USB ports	In accordance with USB specifications
Ethernet	1500 V isolation to Earth

2.2.5 Connect PQube 3 to the power supply

Your PQube 3 can take its operating power from four different sources:

- 24 Vac or ± 24 to 48 Vdc power supply terminals on PQube 3
- Power over Ethernet (PoE)
- Optional PM1/PM2 Power Supply module
- Rechargeable UPS module (automatically provides up to 30 minutes of battery backup when the main power supply source drops out)

PQube 3 power supply terminals

The instrument power terminals (45 and 46) on the front of your PQube 3 must be connected to 24 Vac ($\pm 20\%$) or 24 to 48 Vdc ($\pm 20\%$), supplied by a certified isolating power supply.

WARNING: Applying voltages outside of this range can cause permanent damage to your PQube 3.

Polarity does not matter. Also, your PQube 3 provides a minimum of 150 V of transformer-based isolation between these terminals and all other terminals, eliminating any problems with ground loops.



Power over Ethernet (PoE)

Plug in an Ethernet cable leading to a 48 V PoE source (PoE switch/hub/router or PoE injector).

If no other power sources are available, your PQube 3 will request power from the PoE switch.

If your PQube 3 is already powered from another source (24 Vdc power supply or PM1/PM2 power supply module, for example) then it will not request power from the PoE switch when you plug it in.

PM1 or PM2 Power Supply Module

The PM1 or PM2 module accepts a range of 100 to 240 Vac, 50/60/400 Hz. It plugs into the right side of your PQube 3. This module is ideal for applications where 24 to 48 Vdc, 24 Vac, and PoE are not available. Ensure your AC source can supply at least 20 W.



PM2 front view —
24 Vdc output terminals



PM1/PM2 rear view—
100 to 240 Vac input terminals



PM1 top view—
100 to 240 Vac input terminals

On the PM2 module, 24 Vdc outputs are available on the 8-pin terminal block for powering external accessories including DC Hall Effect sensors and indication LEDs. The first pair of terminals labeled “Switched 24 Vdc” can be toggled on and off in software. The other three pairs are tied together internally. The total combined power output is 5 W, enough to power one additional PQube 3.

UPS Modules

Plug the UPS module on the right side of your PQube 3 or PM1/PM2 module. This module is always the outermost module on the right side.

By default, the UPS timer interval is 5 minutes. However, you can choose the operating duration by writing a value in your **Setup.ini** file. The value can be set from 3 to 30 minutes. This guarantees that there will be enough charge in the battery to record several successive power interruptions.

As the UPS1 lithium-ion battery inside the module ages, its capacity will decline. Depending on operating conditions and requirements, it may be necessary to replace your UPS1 Module every 4 years or 500 cycles, whichever comes first.

The UPS2 and UPS3 allow for the addition of external lead-acid batteries that provide up to 1 hour of battery life. It is recommended to replace your UPS2 or UPS3 battery every 10 years or 300 cycles, whichever comes first.

Maximum Load and Temperature Ratings

Your PQube 3 is rated for 65 °C maximum operating temperature under normal conditions when installed according to the procedures set forth in this manual.

When loading the PM2 module’s 24 Vdc auxiliary circuit with 5 W, the maximum operating temperature is derated to 55 °C.

When the UPS1 module is applied, the maximum operating temperature is derated to 45 °C due to the UPS1 operating temperature range of 0°C to 45 °C.

Power Source	Product Configuration	Auxiliary 24Vdc load	Maximum USB Load	Maximum Load on Relay Outputs	Maximum Operating Temperature
Instrument Power Terminals	PQube 3	No load	USB1 1.5W USB2 0.5W USB3 0.5W	RLY1 loaded with 30 Vdc/30 Vac, 300mA max	65 °C
PM2 AC Input Terminals	PQube 3, PM2	5.15 W max	USB1 0.3W USB2 0.1W USB3 0.1W	RLY1 loaded with 30 Vdc/30 Vac, 300 mA max	55 °C
PM2 AC Input Terminals	PQube 3, PM2, UPS1	No load	USB1 0.3W USB2 0.1W USB3 0.1W	RLY1 loaded with 30 Vdc/30 Vac, 300 mA max	45 °C

2.2.6 Connecting the wires

Observe the wire size specifications and limitations. All conductors must be stranded copper. All conductors and insulation systems and crimped devices must be appropriate for the application. POWERSIDE recommends crimped ferrules on stranded wire. Tighten the screws on the high-voltage terminal block to 0.5 newton-meters (4.4 inch-pounds) of torque. Observe all voltage ratings and limits.

For connections, POWERSIDE recommends wire ferrules for stranded wire, such as Panduit F77 series (for example Panduit F77-6-M).







Your PQube 3 meets all IEC requirements for high-frequency emissions and susceptibility, both conducted and radiated. For further protection, you can use clamp-on ferrites on signal cables to minimize radio-frequency emissions. For example, these are Panasonic KRCBC160928B and KRCBC130714B.

To minimize emissions with the optional PM1/PM2 Power Supply module, optionally use a shielded power conductor.

Conductor characteristics

Connection	Minimum wire size	Maximum wire size	Limitations and remarks. Comply with all local safety and installation requirements and regulations.
PQube 3 terminals L1, L2, L3, N	20 AWG (0.52 mm ²)	14 AWG (2.1mm ²)	Minimum 600V UL-recognized insulation system required. These terminals require less than 0.01 amps. Connection to N (15) is optional. For single phase monitoring, connect either L1-N or L1-L2 as appropriate for the mains configuration.
PQube 3 Earth terminal	20 AWG (0.52 mm ²)	14 AWG (2.1mm ²)	Connect this terminal to a suitable earth connection. For proper PQube 3 operation you must connect this terminal to earth. It is used as a measurement reference, and as a reference for your PQube 3's low-voltage circuits.
Optional PQube 3 terminals	20 AWG (0.52 mm ²)	14 AWG (2.1mm ²)	Minimum 600V UL-recognized insulation system required. Wire size must be adequate for relay contact load. These terminals rated at 30 Vac max, 60 Vdc maximum, 2 A maximum.
All other terminals	20 AWG (0.52 mm ²)	14 AWG (2.1mm ²)	Minimum 600V UL-recognized insulation system required.
PM1 AC Input terminals	20 AWG (0.52 mm ²)	14 AWG (2.1mm ²)	Minimum 600V UL-recognized insulation system required. Shielded cable recommended for minimizing emissions.
PM1 DC Output terminals	20 AWG (0.52 mm ²)	14 AWG (2.1mm ²)	Minimum 600V UL-recognized insulation system required.

Maximum voltages

Connection	Measurement Category	Maximum current	Limitations and remarks
PQube 3 terminals L1, L2, L3, N 	600 Vrms, CAT III		 Corresponds to 480V L-N / 830V L-L max for 3-phase, 4-wire Wye/Star systems. Corresponds to 690V L-L max for 3-phase, 3-wire Delta systems. Corresponds to 480V L-L max for 1-phase, 2-wire Single Phase systems. Corresponds to 480V L-N / 960V L-L max for Split-Single-Phase, 3-wire systems. All voltage channels must be covered after installation.
	300 Vrms, CAT IV		Corresponds to 277V L-N / 480V L-L max for 3-phase, 4-wire Wye/Star systems. Corresponds to 480V L-L max for 3-phase, 3-wire Delta systems. Corresponds to 240V L-L max for 1-phase, 2-wire Single Phase systems. Corresponds to 240V L-N / 480V L-L max for Split-Single-Phase, 3-wire systems. All voltage channels must be covered after installation.
PQube 3 Earth terminal 	N/A		
Optional PQube 3 RLY terminals	30 Vrms or 60 Vdc	0.3 A	
All other PQube 3 terminals	30 Vrms or 60 Vdc		
PM1 AC input terminals 	240 Vrms, CAT II		 Rated for Single-Phase 100 to 240 Vac max. AC voltage input terminal must be covered after installation.
PM1 DC output terminals	24 Vdc	0.42 A	10 W maximum output
USB1 Input	5 Vdc	0.2 A	
USB2 and USB3	5 Vdc	0.1 A	

Note: “CAT III” means Measurement Category III as defined in UL / IEC 61010-1
 “CAT IV” means Measurement Category IV as defined in UL / IEC 61010-1

2.2.7 Connect Mains AC Voltage Wires

The large high-voltage terminal block on the back of your PQube 3 is removable. Refer to the wiring diagrams and use the appropriate wiring scheme for your power configuration.

IMPORTANT: Don't forget to install the Earth conductor. Your PQube 3 relies on the Earth conductor for safety, reliability, and accuracy.

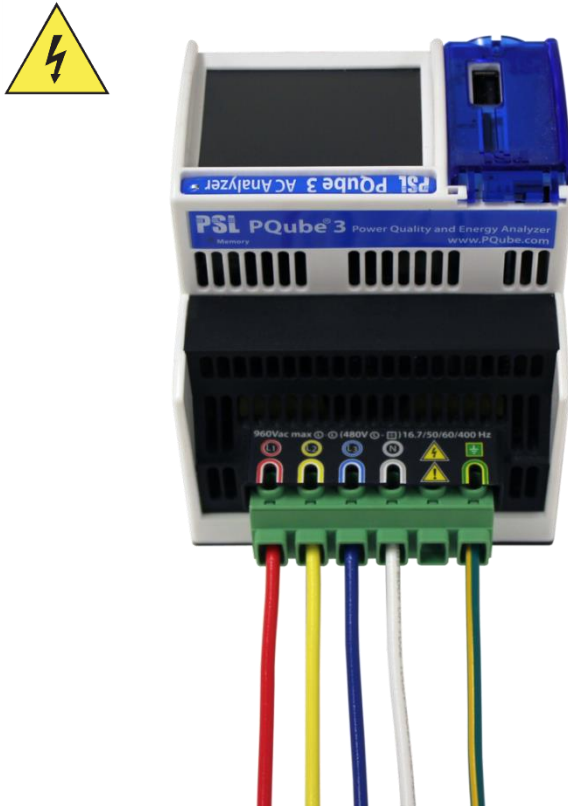

You must apply at least 30 Vac to these terminals before your PQube 3 will begin recording.

2.2.8 Protect antenna terminals from lightning

If you install an antenna in an outdoor location where it may be exposed to lightning, you must include a properly installed UL-497C-listed lightning protection device on the antenna cable and the antenna must be reliably earthed. Follow all local installation safety requirements and regulations.

2.2.9 Installing a PM1 or PM2 Power Supply Module



The optional PM1 or PM2 Power Supply Module connects to the right side of your PQube 3; just plug it in. It accepts any 50/60/400 Hz single-phase input between 100 Vac and 240 Vac nominal. Verify that you are connecting the line and neutral wires to the correct terminals on the module.

2.2.10 Installing UPS Module



The UPS1 Module provides backup power to your PQube 3 in the event of complete loss of instrument power. Plug it into the right side of your PQube 3. If using a PM1 Power Supply Module, plug the UPS module into the right side of the PM1/PM2 module. The lithium-ion battery pack can provide power between 3 and 30 minutes (user-configurable).

If more power duration is required, the UPS2 or UPS3 with an external battery pack can be used.

2.2.11 Installing Split Core Current Transformers (CTs)

Note: You can skip this chapter if you are installing PQube 3v or PQube 3vr (voltage analyzers)

Your PQube 3 records AC current by measuring the secondary circuit of a current transformer (CT).

When installing current transformers, it is important to match the phases to the voltage inputs and current input (connect the L1 voltage input and the L1 current sensor to the same conductor). This is necessary for correct power and energy calculations.

Instructions for setting your CT ratio can be found in section “Set Current Transformer (CT) Ratio”.

IMPORTANT: You must only use UL listed energy monitoring current transformers with your PQube 3.

A note on choosing the appropriate range of CTs for your application:

If the PQube 3 is installed to monitor power and load, the nominal rated current of the CT should be the most common load current throughout the consumption period (e.g., workdays). Your PQube 3 makes current measurements with a Crest Factor of 3.5. This means that your PQube 3 can measure instantaneous currents up to 350% of the nominal rated current (for example, if you have selected a 300 A current transformer, your PQube 3 will accurately measure up to ± 1050 A instantaneous). This is a very useful feature when dealing with inrush currents, and currents with high harmonic contents.

If the PQube 3 is installed to troubleshoot circuit breaker trip operation, the nominal rated current should be selected closer to the trip settings. In all cases, the PQube 3 crest factor of 3.5 provides a margin to properly capture the peak currents.

Note: POWERSIDE Ultra-Precise CTs:

POWERSIDE Ultra-Precise CTs are specifically designed for your PQube 3. Ultra-Precise split core CTs are calibrated, shielded, and specifically designed to meet demanding accuracy applications.

The POWERSIDE Ultra-Precise CTs exceed the ANSI C12.20 standard for Class 0.2.

This is important if you need to measure high-order current harmonics or if you need revenue-grade accuracy for your application.

**Note:**

Each CT is calibrated to match the input impedance of your PQube 3's current input channels. Each Ultra Precise CT has its own NIST-Traceable calibration certificate and has a calibration file saved to USB drive that you can upload to your PQube 3.

POWERSIDE Ultra-Precise CTs are UL listed and utilize a 0.333 Vac secondary output to match your PQube 3's current input terminals. A burden resistor is built into the CT, so you do not need to worry about hazardous open circuit voltages.

You can see the list of available POWERSIDE Ultra-Precise CTs for your PQube 3 here:

<http://powerside.com/pqube-3-accessories/>

You can look up the calibration certificate for your CTs here:

<http://powerside.com/certificates/>

Installing Split Core CTs with 0.333 Vac secondary

Your PQube 3 comes standard with 8 current input channels, which are typically used to measure L1, L2, L3, N, E, plus 3 additional single-phase channels. The current channels on your PQube 3 are rated for 0.333 Vac nominal inputs and designed to be used with CT secondary 0.333 Vac.

For POWERSIDE CTs, white wires are positive and black wires are negative.

If using POWERSIDE Ultra-Precise CTs with the shielded secondary wires, the red or white wire is positive and the black wire is negative. Connect the shield conductor to ground. If using another manufacturer's CTs, verify which wires are positive and negative before installing them.



Clamp the CT around the conductor. For all POWERSIDE CTs, the label faces towards the source.



Installing Flexible/Rogowski Current Sensor FCT-XX-3000A

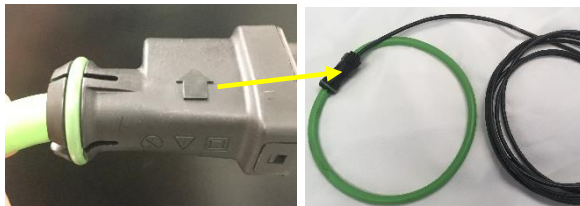

The arrow
must face
the source

The flexible AC current sensors (Rogowski coils) are perfect for applications where limited space makes installation of traditional current transformers difficult or impossible. Their pliable split-core design allows you to easily clamp around cables or bus bars.

- Plugs directly into your PQube 3—built-in integration but must be configured in setup.ini
- Flexible, IP65 weather resistant loop
- Four-meter cable shielded for noise immunity
- UL approved, RoHS, and WEEE compliant
- Nominal 30 A to 3000 A measurement range
- Typical amplitude accuracy: $\pm 0.5\%$
- Typical angle accuracy: ± 1 deg
- No magnetic hysteresis (saturation or non-linearity)

Installing CTs at the secondary of measuring current transformers (1 A or 5 A secondary)

If you will be monitoring the 1 A or 5 A secondary of existing metering CTs, you will need to use the CTI-1A or the CTI-5A module. They have 1 A and 5 A nominal inputs, respectively.

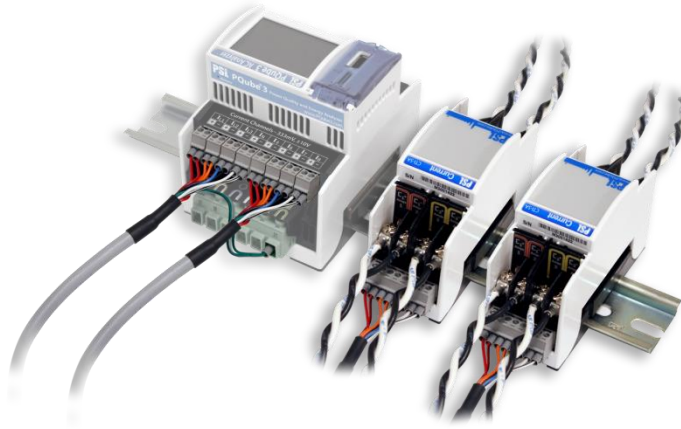

The CTI module inputs are installed in series with your 1 A or 5 A secondary circuit. The terminal block on your CTI module is connected to the 0.333 Vac current input channels on your PQube 3. Each CTI module includes 4 current channels, so you can use up to 2 CTI modules per PQube 3.



WARNING: When installing CTs with 1 A or 5 A secondaries, take extra precautions to ensure that an open circuit does not develop on the secondary wires. Shorting blocks are typically used to avoid the possibility of an open circuit during installation. CTs must be installed only by qualified personnel for electrical installations.

1 A or 5 A vs. 0.333 Vac secondary, what's the difference?

Most current transformers are designed to have 1 A or 5 A of current flowing through the secondary circuit while full rated current is flowing through the primary circuit.

While installing CTs with 1 A or 5 A secondary, it is imperative that an open circuit does not develop in the secondary. If an open circuit develops while current is flowing through the primary of the CT, a very hazardous open circuit voltage (OCV) will develop across the opening. In this condition, typical OCV values can range from hundreds to thousands of volts.

For this reason, POWERSIDE offers CTs exclusively with 0.333 Vac secondary. Our CTs includes a built-in burden resistor in the secondary circuit so that the current always has a path to flow through. The resistor value is calibrated and tuned to achieve a 0.333 Vac drop across the resistor at full rated current. This 0.333 Vac signal can then be measured using the 2 wires coming out of the CT.

2.2.12 Connecting the ENV2 Environmental Probes

ENV2 probes interface with the PQube 3 through a USB cable. Insert the USB connector into the USB-2 and USB-3 slots of the PQube 3. You can connect up to 2 probes to your PQube 3.

Note: if necessary, the probe can be connected to the front USB-1 slot, but you cannot extract data over USB while the probe is occupying this port.

You can verify the proper operation of the environmental probe by checking the local PQube 3 display in the “Meters” menu.



2.2.13 Connecting the Output relay (RLY1)

Your PQube 3 comes with an embedded relay that you can configure to trip on event triggers. The list of triggering conditions can be found in the PQube 3 reference manual.

The RLY1 relay is a normally closed switch, which opens upon event detection for at least 3 seconds, or for the duration of the event whatever is longer. The relay trips when the PQube 3 shuts down or restarts.

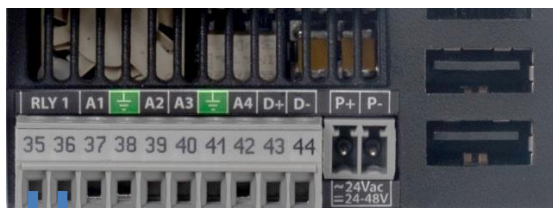

Normally Closed. Opens upon event trigger

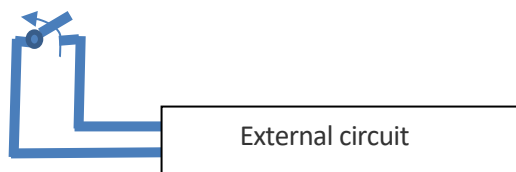

2.2.13.1 PQube 3 Relay State (RLY1)

The table below describes the relay state with respect to conditions, events, and power sequences.

Relay & Condition		Relay State			
Relay	Event in progress	Event Trigger	UPS1/2/3 operated shutdown	Power loss	Manual operated reboot
RLY 1	NO	OPEN	OPEN	CLOSED	OPEN
RLY 1	YES	OPEN	OPEN	OPEN	OPEN

2.2.14 PQube 3r/3vr: Connecting the Output relays (RLY2, RLY3, RLY4)

All PQube 3 power analyzers have one relay, RLY1 described in the section above.

However, the PQube 3r and PQube 3vr come with an additional 3 relays: RLY2, RLY3, RLY4.

Each of these relays have a 3-pole terminal to connect the external logic circuit. They trip for at least 3 seconds or for the duration of the event whatever is longer. There is also an option to latch the relay state that enables maintaining the relay state during an event trigger.

The following shows how to connect the relay(s) for Normally Closed (NC) operation (RLY2 wiring shown):

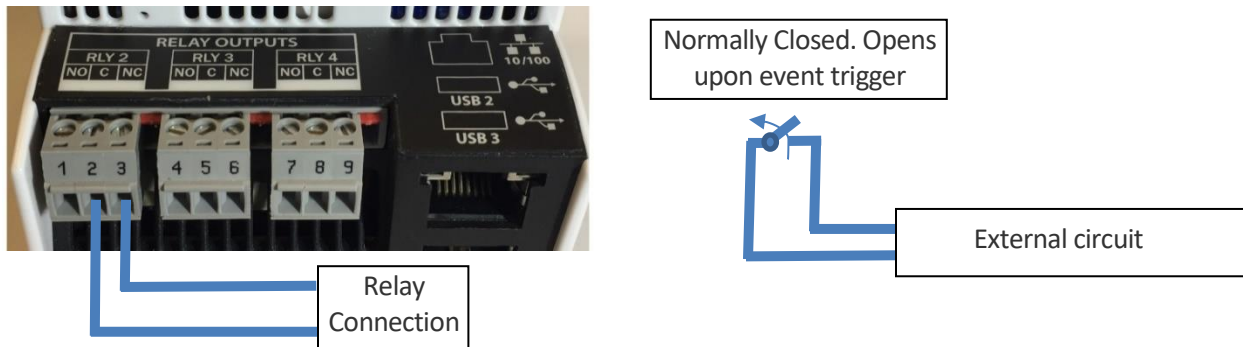

The following shows how to connect the relay(s) for Normally Open (NO) operation (RLY3 wiring shown):

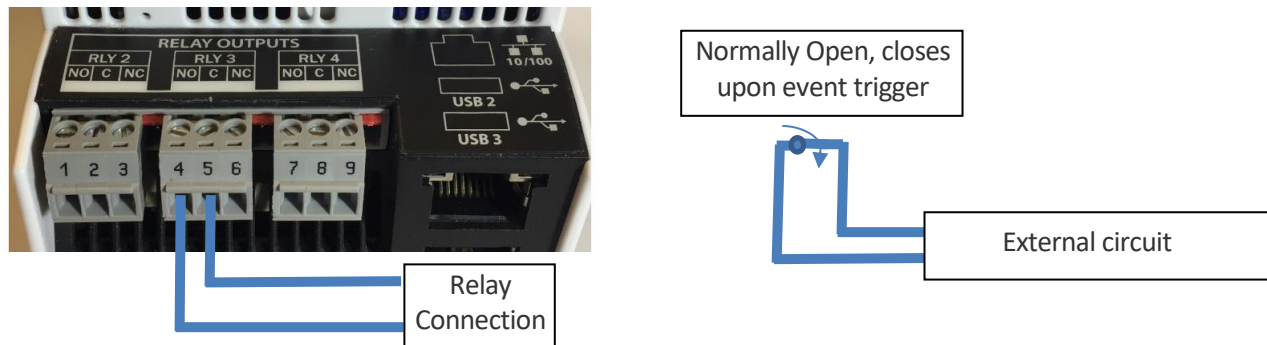

2.2.14.1 PQube 3r/3vr Relay State (RLY2, RLY3, RLY4)

The table below describes the relay state when wired normally closed to common pin (NC-C) with respect to conditions, events, and power sequences.

Relay & Condition				Relay State			
Relay	Wiring	Latching Enabled	Event in progress	Event Trigger	UPS1/2/3 operated shutdown	Power loss	Manual operated reboot
RLY 2-4	NC-C	OFF	NO	OPEN	OPEN	OPEN	OPEN
RLY 2-4	NC-C	ON	NO	OPEN	CLOSED	CLOSED	CLOSED
RLY 2-4	NC-C	OFF	YES	OPEN	OPEN	OPEN	OPEN
RLY 2-4	NC-C	ON	YES	OPEN	OPEN	OPEN	OPEN

The table below describes the relay state when wired normally open to common pin (NO-C) with respect to conditions, events, and power sequences.

Relay & Condition				Relay State			
Relay	Wiring	Latching Enabled	Event in progress	Event Trigger	UPS1/2/3 operated shutdown	Power loss	Manual operated reboot
RLY 2-4	NO-C	OFF	NO	CLOSED	CLOSED	CLOSED	CLOSED
RLY 2-4	NO-C	ON	NO	CLOSED	OPEN	OPEN	OPEN
RLY 2-4	NO-C	OFF	YES	CLOSED	CLOSED	CLOSED	CLOSED
RLY 2-4	NO-C	ON	YES	CLOSED	CLOSED	CLOSED	CLOSED

2.2.14.2 PQube 3r/3vr Relay State: DNP3.0 Binary Output

The table below describes how relay states will behave when subjected to DNP3.0 trip and close commands. Both wiring configurations, normally open (NO-C) and normally closed (NC-C) are considered. Refer to the PQube 3 DNP3.0 Reference Manual for further information on configuring the DNP3.0 binary outputs.

Relay & Condition			Relay State	
Relay	Wiring	Latching Enabled	DNP Close Command	DNP Trip Command
RLY 2-4	NC-C	Yes	CLOSE	OPEN
RLY 2-4	NO-C	Yes	OPEN	CLOSE

2.2.15 Installing GPS-R Sync Module (GPS Synchronization)

The optional GPS-R Sync Module connects to the left side of your PQube 3; just plug it in. Connect the module before supplying power to your PQube 3. The GPS-R Sync Module interfaces with an OEM TNC type GPS antenna using an RG58c/U cable.



3 Wiring Diagrams

3.1 Wiring diagram for PQube 3v and PQube 3vr

*PQube 3v, PQube 3vr
measures voltage only*

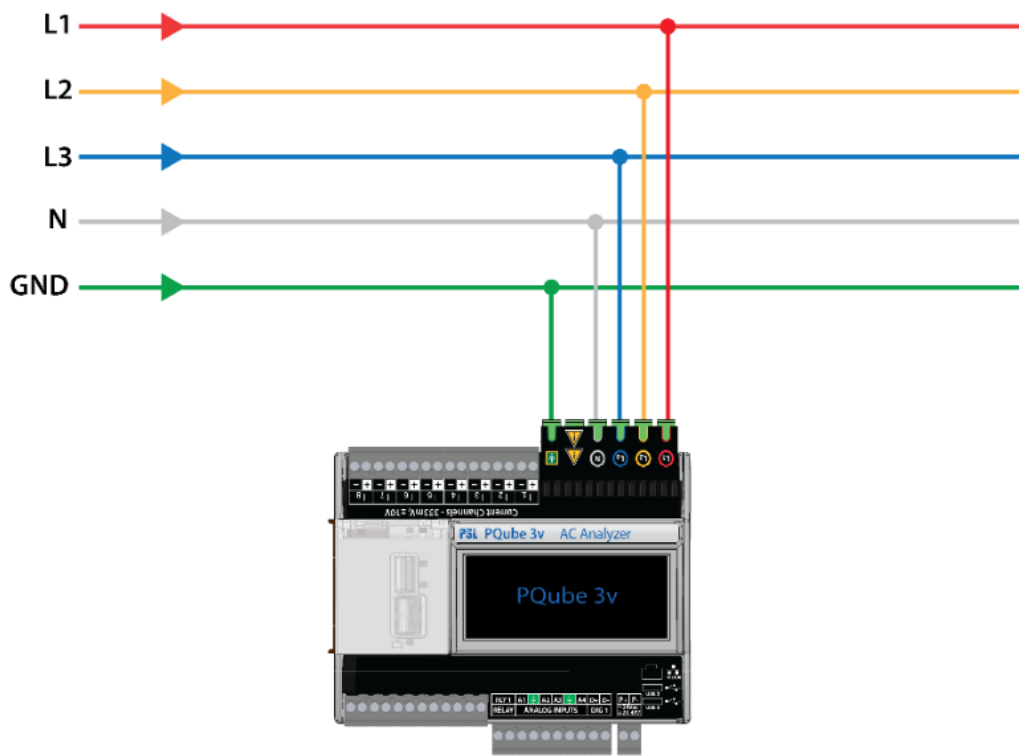

3.2 Wiring Diagrams (PQube 3, PQube 3e, PQube 3r)

3.2.1 Single Phase L1-N

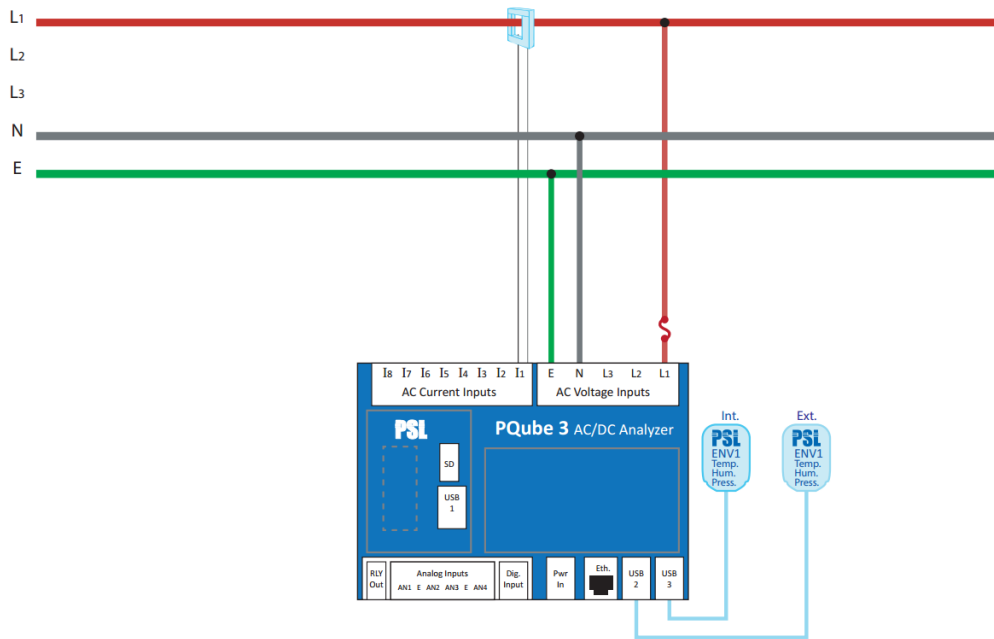

3.2.2 Single Phase L1-L2

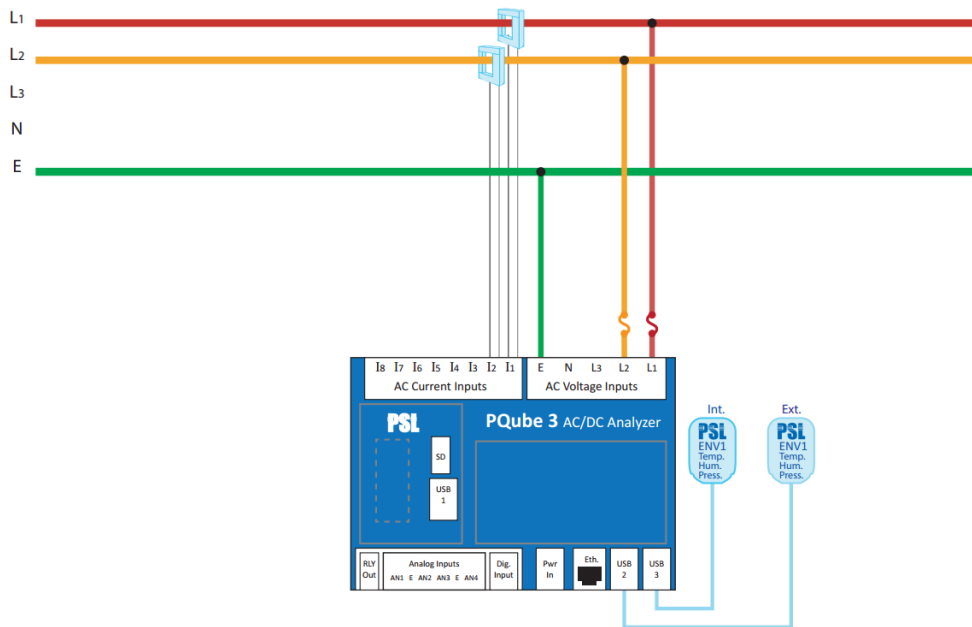

3.2.3 Single phase 3-wire / Split Phase

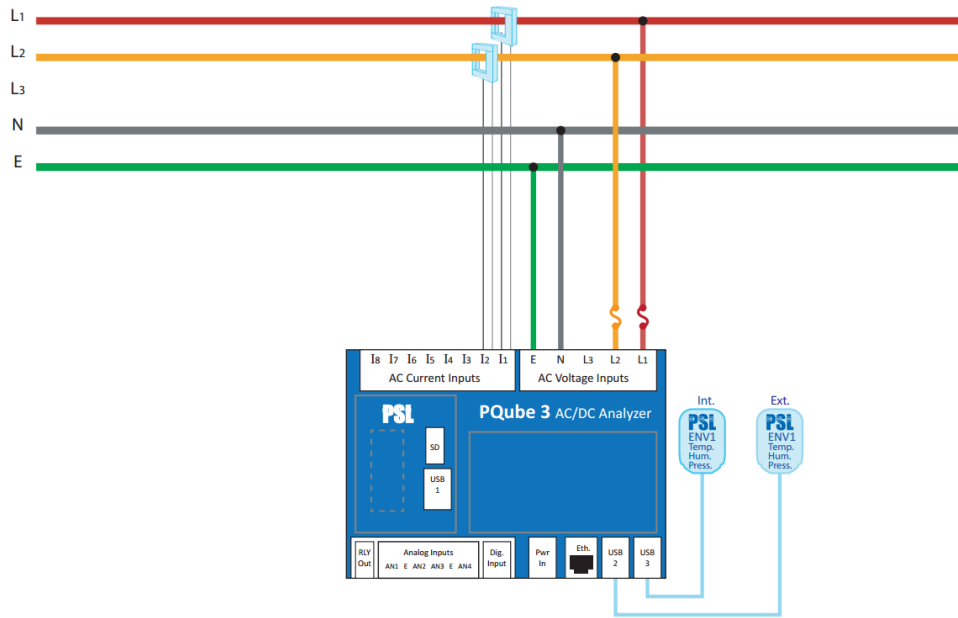

3.2.4 Delta—3 CTs

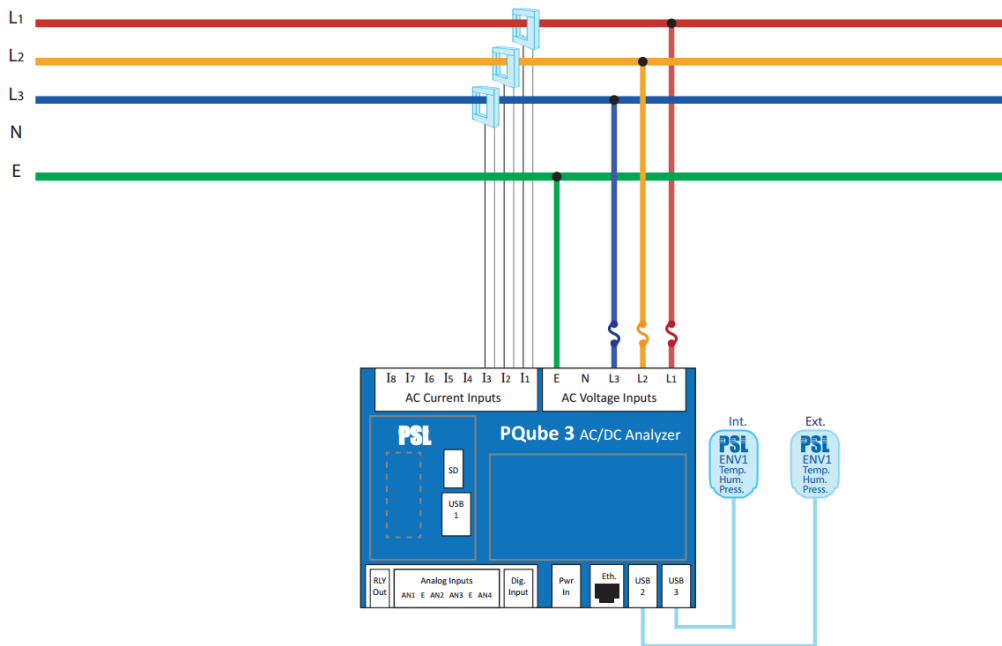

3.2.5 Delta—2 CTs

Note: PQube 3 calculates current on remaining channel

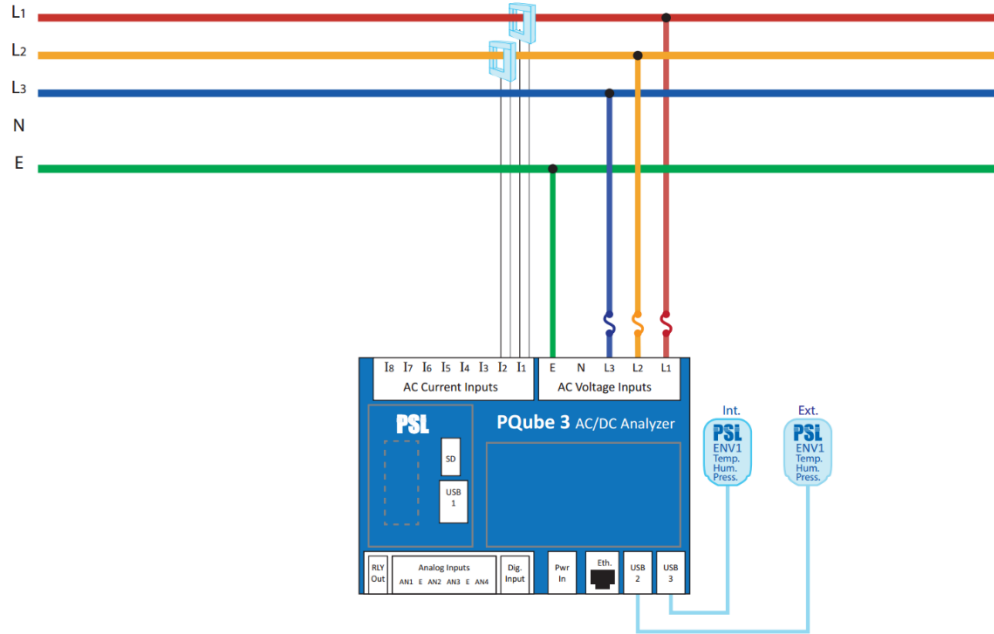

3.2.6 Wye/Star

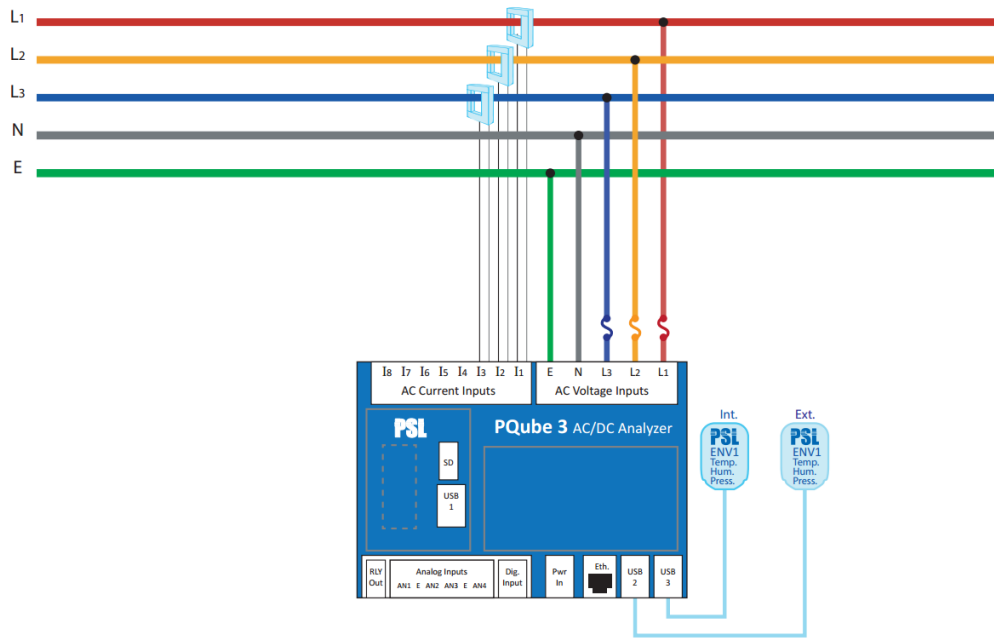

3.2.7 Measuring Neutral Current

This applies to any power configuration with Neutral conductor accessible

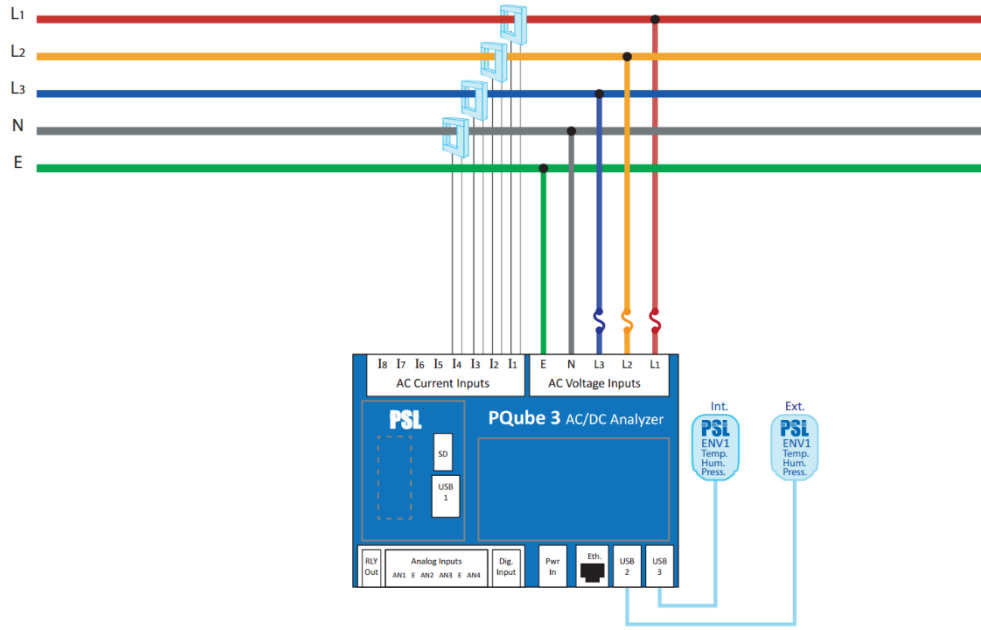

3.2.8 Measuring Earth Current

This applies to any power configuration

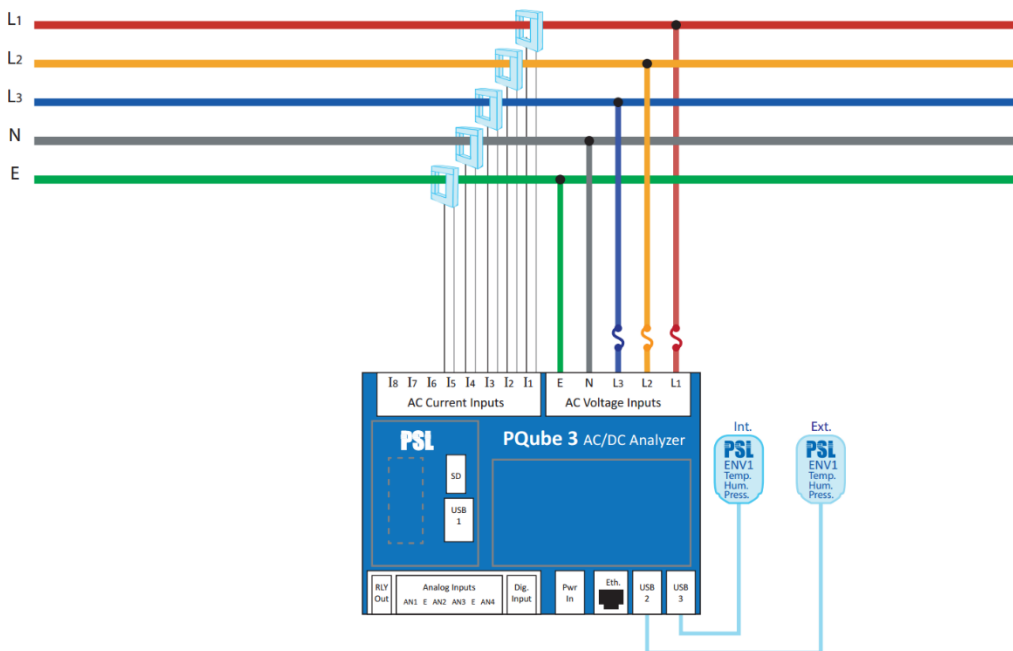

3.2.9 Measuring Net Earth Current—Delta

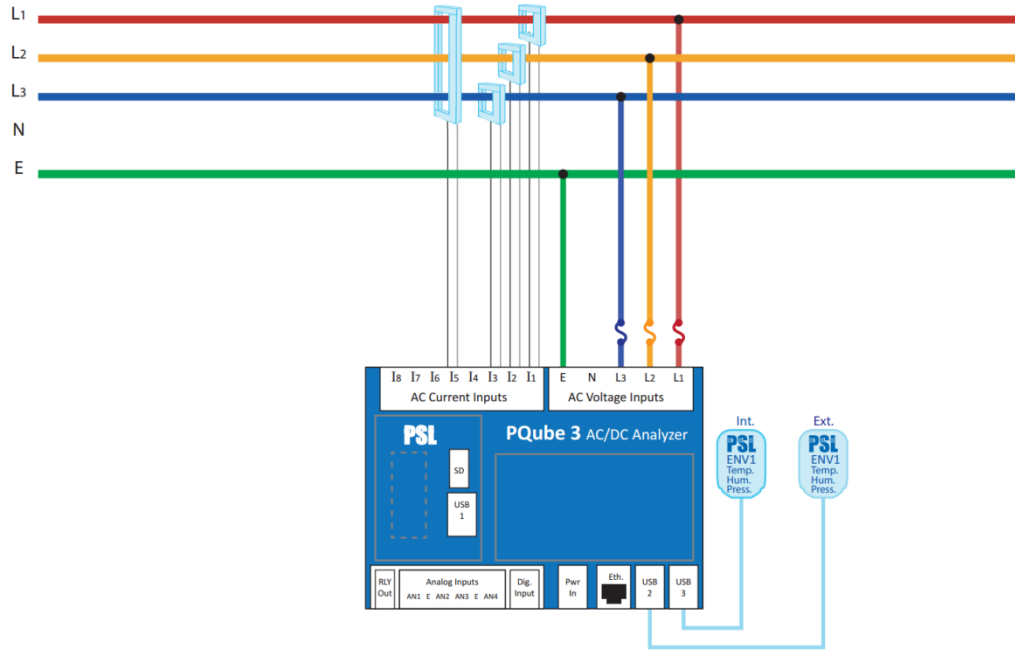

3.2.10 Measuring Net Earth Current—Wye/Star

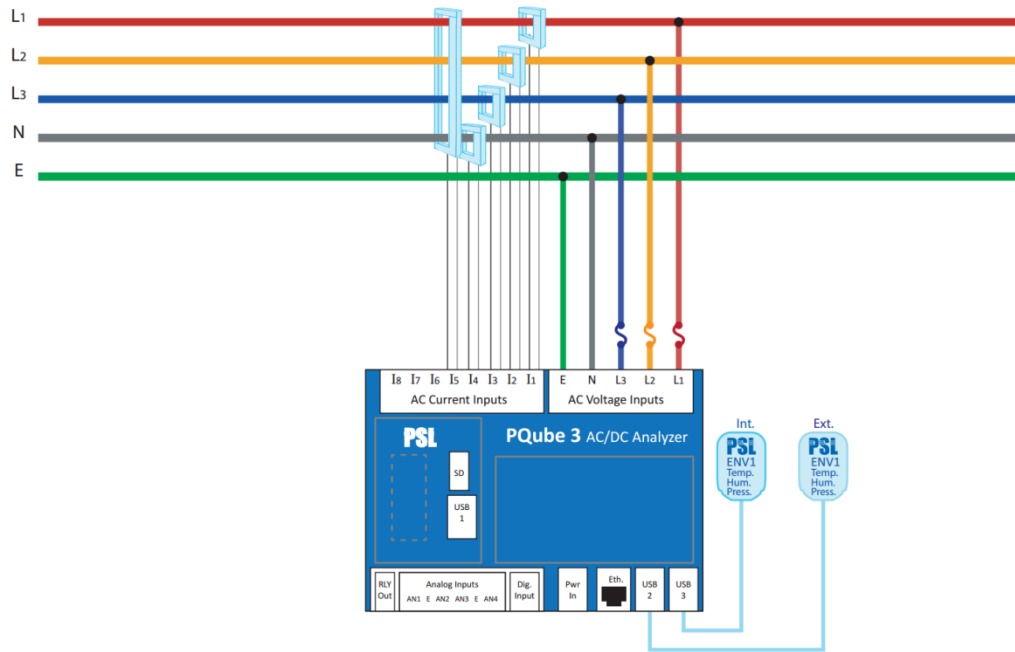

4 Configuring the PQube 3

4.1 Using the Configurator

Your PQube 3 comes with a factory default configuration. This configuration is an ASCII file (**setup.ini**).

To customize your individual configuration, you can edit it using the PQube 3 Configurator program. This graphical editing utility is simple to use and will help avoid mistakes and conflicts across various dependent parameters.

You could use (but not recommended) a text editor like Notepad to edit the setup.ini.

You can download the PQube 3 Configurator program for free on the Powerside Help/Download Center: <https://help.powerside.com/knowledge/pqube-3#pqube-3-configurator>

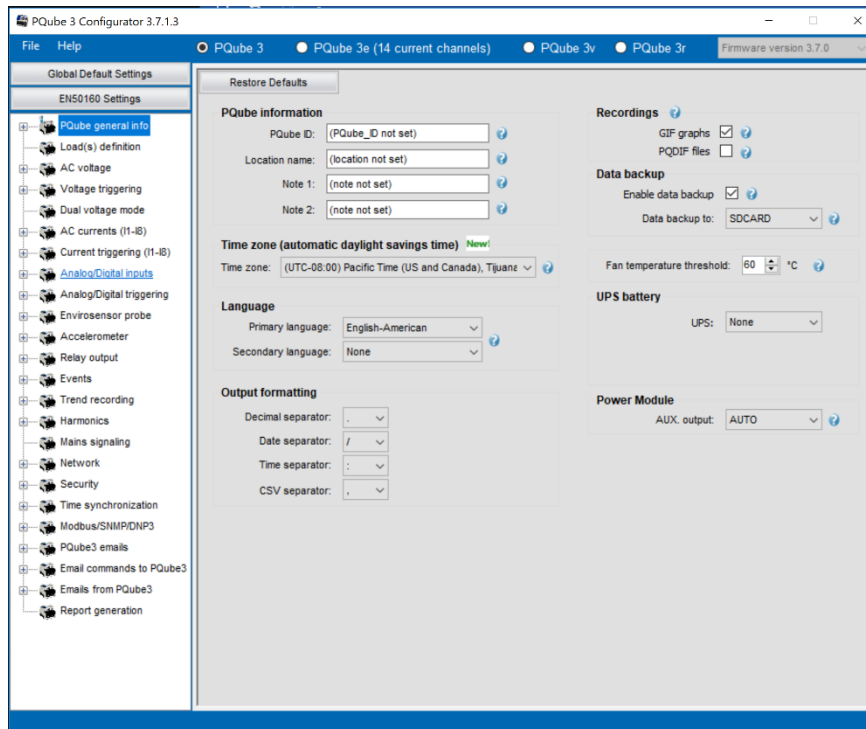

After you've made your changes, save the file as **Setup.ini** and upload it back to your PQube 3 via email, web, FTP, and it will automatically reboot and load the new settings on startup. You can also copy your new setup file onto a USB drive or microSD card (32 GB max) and insert it directly into your PQube 3. After detecting the new Setup file, your PQube 3 will ask you to reboot so it can load the new settings.

Notes:

- The factory-default setup file is identical to the USB drive that shipped with your PQube 3.
- If you are installing a PQube 3 which has been used previously, you may want to use a copy of that configuration, and then edit it with the Configurator.

- You can retrieve your PQube 3’s existing setup file via USB stick locally, or remotely via email, web pages, or FTP.

4.2 Initial Device Setup

Your PQube 3 will work right out of the box. Once your PQube 3 has been installed, connected to the monitoring circuit, and powered on, it will begin recording data immediately. The default settings will work for most applications. Set Potential Transformer (PT) Ratio

If you monitor voltages above 960 Vac Phase-to-Phase (480 Vac Phase-to-Earth), you need to interface to the secondary of a potential transformer (which steps down the voltage to a level compatible with your PQube 3).

You then need to define the PT ratio in the configuration so that your PQube 3 reports the actual primary voltage.

For example, to use your PQube 3 on a 24 kV distribution system, and use a secondary voltage of 240 Vac, you need to set a 100:1 PT ratio.

In the Configurator, set the PT ratio to 24000:240 or 100:1. You will also need to set your nominal voltage using the primary voltage of your PT. Even though your PQube 3 has 240 Vac applied to its mains AC voltage terminals, you need to set the nominal voltage to 24,000.

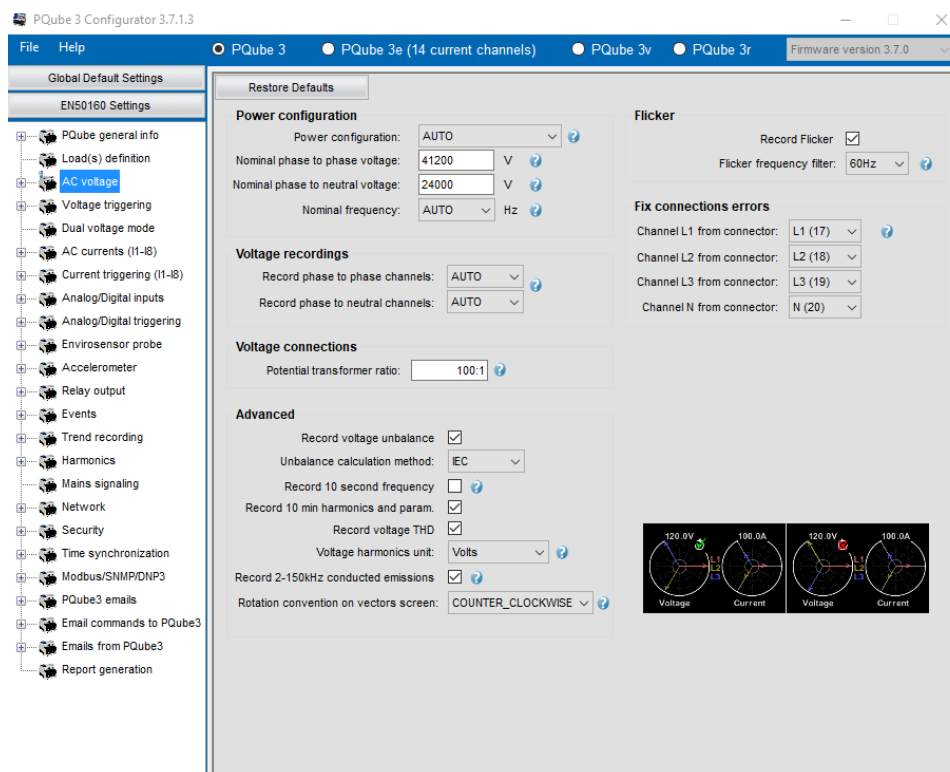

For the PQube 3v, ONLY the voltage settings are set as there are no current inputs.

4.2.1 Set Current Transformer (CT) Ratio

Note: you can skip this chapter if you are installing a PQube 3v or PQube 3vr (voltage analyzer).

4.2.1.1 If you are using CTs with 0.333 Vac secondary

To set the CT ratio, simply enter the primary current and secondary voltage into your CT ratio. For example, if you have a current transformer rated at 300 A, with 0.333 Vac secondary, then you would set your CT ratio to 300:0.333. The value in the **Current Transformer Ratio** field is applied to the L1, L2, and L3 current channels.

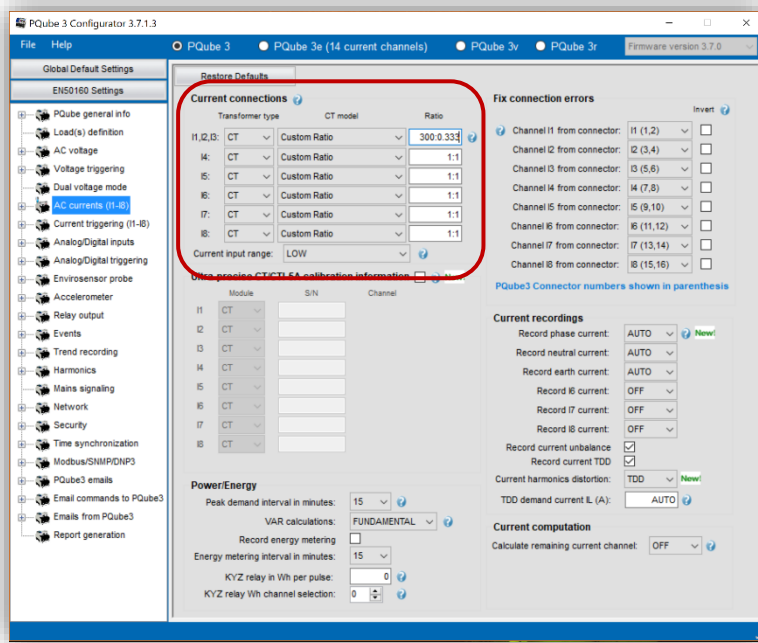

4.2.1.2 If you are using CTs with 1 A or 5 A secondary

Use the CTI-1A or CTI-5A modules are designed to accept the 1A or 5A secondary of metering CTs. The CTI-1A module has a ratio of 1A:0.333 V. The CTI-5A module has a ratio of 5A:0.333V. To calculate your CT ratio, multiply the ratio of your metering CT by the ratio of your CTI module.

	CT Ratio	CTI Module	CT Ratio Calculation	CT Ratio in Setup File
Example 1	300A:5A	CTI-5A module	$\frac{300A}{5A} \times \frac{5A}{0.333V} = \frac{300A}{0.333V}$	300:0.333
Example 2	500A:1A	CTI-1A module	$\frac{500A}{1A} \times \frac{1A}{0.333V} = \frac{500A}{0.333V}$	500:0.333

4.2.1.3 Verify the PQube 3 blinks in Green



The first step of the verification is to make sure that the main LED of the PQube 3 blinks in GREEN.

Your PQube 3 will not begin recording until it has locked onto the power configuration. The minimum lock-on voltage is 30 Vac applied between L1 and N, or between L1 and L2.

If not blinking green, go to the troubleshooting chapter.

4.2.1.4 Check Power Configuration

From the main menu on the touchscreen display, go to System, Config, Power Config. Verify that the power configuration, nominal voltage, and nominal frequency look correct. This is important for proper event detection and data recording.

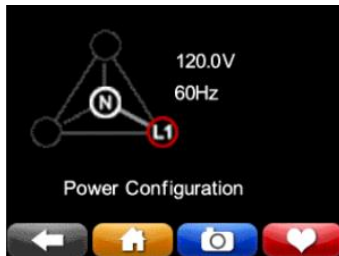

4.2.1.5 Verify meter readings



From the display, press the Meters button and check that everything looks correct. If you entered PT and CT ratios into your setup file, verify that your voltage and current values look appropriate. Also make sure that your values for power (watts) and power factor look appropriate. If you have inverted your CTs or installed the CTs on the wrong phases, your power readings will be inaccurate.

4.2.1.6 Verify Voltage and Current Vectors

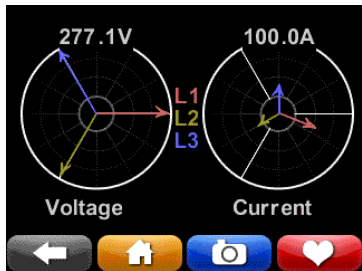

You will also want to verify that your voltage and current vectors look appropriate. Our vector convention for a balanced 3-phase system is L1 voltage at 0° , with L2 voltage at -120° and L3 voltage at $+120^\circ$.

4.2.2 Troubleshooting: Common Installation Errors

Negative Sequence Unbalance Excessively High

If your PQube 3 reports an excessively high negative sequence unbalance ratio, this means your phase rotation is reversed. If you were connecting a 3-phase motor using this sequence, it would begin rotating in the opposite direction as intended. To change your phase rotation, swap any 2 phases.

Power Readings Lower Than Expected

If your watts and power factor readings are much lower than expected, double-check that your CTs are installed on the correct conductors. For example, if your L1 current sensor is installed on the L2 conductor, your L1 power will be much lower than expected, and possibly negative.

Unexpected Negative Power Readings

During installation, it is easy to make a mistake in your current transformer connections, either by reversing the secondary connections or by feeding the main power conductor through your current transformer backwards.

It is important to correctly connect your CTs (or use the method above to correct a wiring error). Power (watt) calculations are made by multiplying the instantaneous current by the instantaneous voltage. If one or more of your current transformers is incorrectly set up, your PQube 3 will calculate negative power for that phase.

You can always shut the power down and open up the cabinet to fix your wiring; an easier way is to invert your CT polarity in your setup file.

For example, if you realize that you have installed your L2 current transformer backwards, just invert the L2 current channel in your setup file.

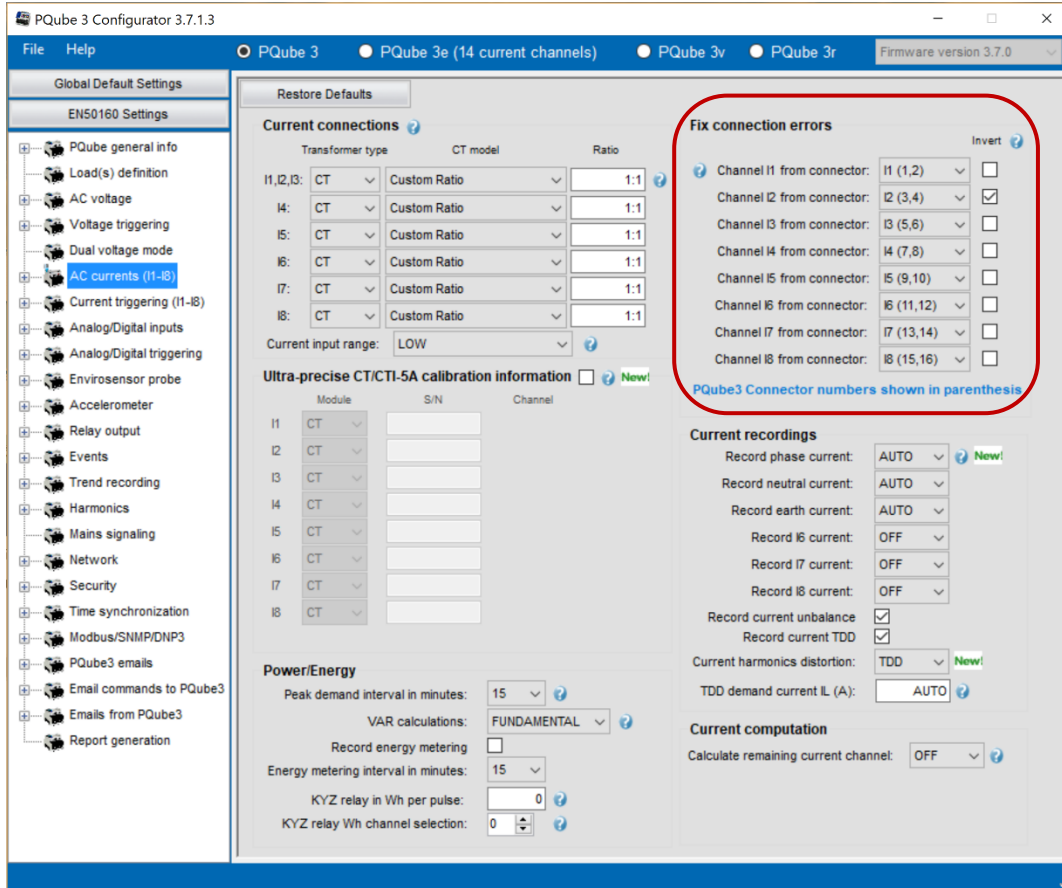

PQube 3 Not Locking on to Power Configuration

Your PQube 3 does not have an ON/OFF switch for recording data. It is designed to automatically begin recording data as soon as it has locked onto the power configuration. If it cannot lock onto a power configuration, it cannot record data and will blink orange.

If your PQube 3 is having trouble locking on, check the following:

You need to have at least 30 Vac applied between the L1 and N terminals or the L1 and L2 terminals.

Next, verify that you've connected the Earth conductor to your PQube 3. If you forget to install the Earth conductor to your PQube 3, your PQube 3 may have problems locking onto the power configuration. Connecting the Earth conductor is required to ensure the safety, reliability, and accuracy of your PQube 3.

Still need help? Contact us at support@powerside.com.

5 Maintenance

5.1.1 Turning Off PQube 3

Your PQube 3 is designed to be a permanently installed monitor. It does not have an on/off switch because it is designed to run continuously. If you need to turn off your PQube 3, remove your PQube 3's instrument power (either the power screw terminal block on your PQube 3, the optional PM1 Power Supply Module, or PoE). Your PQube 3 will automatically initiate graceful shut down to prevent any write damage to flash.

If you have a UPS module installed, your PQube 3 will continue to run for the allotted amount of time. To immediately power down the device while on backup power from the UPS module, go to the Actions screen and press Reboot. With no permanent power source available, your PQube 3 will simply turn off.

5.1.2 Replacing PQube 3's Clock Battery

Your PQube 3 uses a user-replaceable, non-rechargeable lithium-manganese coin cell battery to back up the system clock in the event of instrument power loss. POWERSIDE recommends replacing this battery every 10 years. When you order a replacement battery, always remember to power off the device first, disconnect mains connections, and verify disconnections.



To remove and replace the battery, insert a small flat-head screwdriver to pry up the label near the USB port and microSD card slot. Remove the old battery and install the new one. It is not possible to install the battery with the wrong polarity.

Follow all applicable federal, state, and local regulations when disposing of a used battery.



Disconnect power to the device before replacing the battery.

Replace battery with a POWERSIDE-supplied battery only. Use of another battery may present a risk of fire or explosion. This part must be supplied only by POWERSIDE or POWERSIDE agents.

5.1.3 Life Expectancy of the PQube 3 and the PM1/PM2 module

The estimated life expectancy of a PQube 3 and its PM1/PM2 module is 10 years (based on operating ambient temperature at 23° C).

5.1.4 UPS1 Life Expectancy and Long-Term Storage Instructions

As the lithium-ion battery inside the module ages, its capacity will decline. Depending on operating conditions and requirements, it is recommended to replace your UPS1 Module every 4 years or 500 cycles, whichever comes first. The UPS1 operating temperature range is 0°C to 45 °C.

If you need to store your PQube 3 and modules on the shelf for 3 months or longer, remember to fully charge the batteries in your UPS1 module before placing them in storage. To fully charge the batteries, turn on your PQube 3 with the UPS1 module plugged in, and let it run for at least 1 day.

POWERSIDE recommends charging your UPS1 modules every 6 months while they are in storage. The UPS1 storage temperature range is -20°C to 35 °C.

5.1.5 Cleaning Instructions

If necessary, wipe the accessible parts of your PQube 3 with a slightly damp cloth while it is powered off. Do not use abrasives or chemical cleaners and do not clean your PQube 3 while it is powered on.

5.1.6 Reasons for reset

If your PQube 3 is configured to email you whenever system activity occurs, it will notify you whenever it has reset.

Reset reasons	Description
System Timeout reached	One of the processes of the PQube 3 is stuck or takes too much time to complete compared to expected result
Setup File Sent	A new setup.ini file has been sent
Update Required Restart	A firmware update was sent and the PQube 3 restarted
User Triggered Display Reboot	The touchscreen <Action> <reboot> has been used
Web Command Reboot	A reset has been requested from the web command page
Battery Timeout Reached. Battery Percentage: XX%	The PQube 3 has shut down after reaching the configured autonomy of battery (see PQube 3 configuration).
Unspecified Reason	No reason identified (default)

5.1.7 Calibration Information for Your PQube 3

Every PQube 3 is calibrated and traced to NIST at the factory. You can download a free NIST trace certificate that contains the specific calibration information for your PQube 3 by entering your PQube 3's serial number at <https://www.powerside.com/certificates>.

END OF DOCUMENT